

Roben

*Ceramic roof tiles
and accessories*

ROOF TILES



New



Technical data*

Weight (1 item)	ca. 3.90 kg
Total length	ca. 46.6 cm
Total width	ca. 30.6 cm
Length of cover	ca. 35.7-39.8 cm
Average width of cover	ca. 24.3 cm
Minimum design value/m²	ca. 10.3 items
Quantity/m ²	ca. 10.3-11.5 items
Minimum roof inclination angle	up to 22°
Quantity/EURO pallet	240 items
Weight per sqm	ca. 40.2-44.9 kg
Weight of full pallet	ca. 966 kg
Frost resistance	yes

* technical parameters may be slightly changed

Properties

- aesthetic and solid appearance
- larger format
- allows the use of different fixing brackets
- displacement tolerance of up to 41 mm
- deeper and higher locks

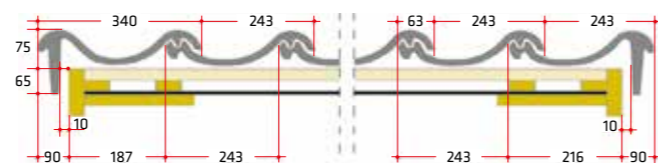
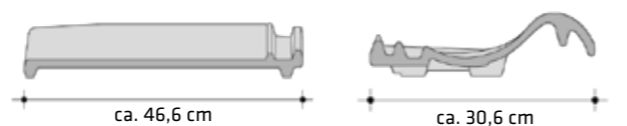

Extreme roof tile

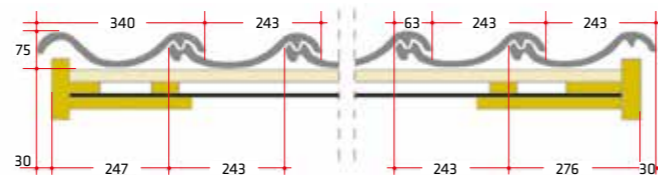

Double Roman roof tile

Elegant, traditional effect of wavy lines



Roof battens 30x50 mm

MILANO	LAF/FLA (mm)											
Roof inclination angle	10°	14°	18°	22°	25°	30°	35°	40°	45°	50°	55°	60°
GAŠIOR												
LAF	58	58	56	56	56	56	54	54	54	54	54	54
FLA	164	158	152	146	142	136	130	124	116	110	104	98

Roof battens 40x60 mm

MILANO	LAF/FLA (mm)											
Roof inclination angle	10°	14°	18°	22°	25°	30°	35°	40°	45°	50°	55°	60°
GAŠIOR												
LAF	56	54	52	52	50	48	46	46	46	44	44	44
FLA	174	168	162	158	152	148	142	136	132	126	122	118

Cross-section of the roof cover.

Proper assembly depends, inter alia, on the shape of the roof and location of the house, which is why it may be different from the solutions presented here. The best option is to consult a qualified roofer. Please read the guidelines for proper roof ventilation. Details can be found in the information sheets at www.en.roben.pl.

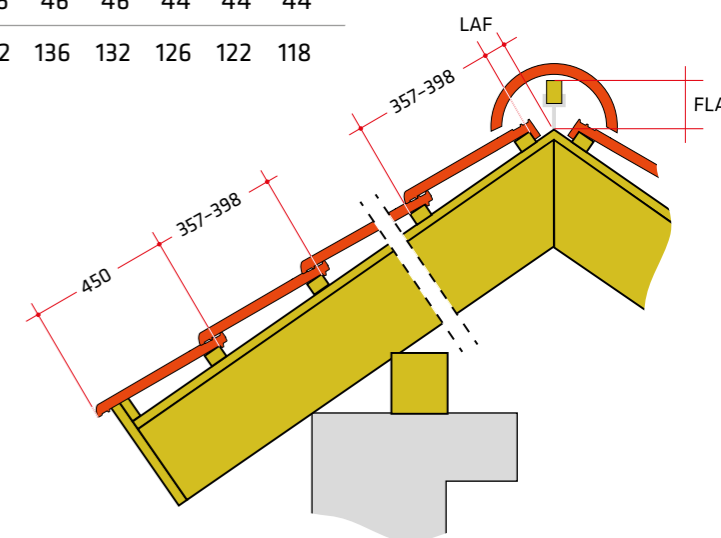

Available colours of roof tiles



Natural red



Anthracite engobed

MILANO / Natural red

New



MILANO / Anthracite engobed

New





Right edge tile



Left edge tile



Ventilating tile



Double roll tile



Basic ridge tile with a clamp - 2.9 pcs./l.m.



Large, semi-circular initial ridge tile



Ceramic antenna tile



Crest ridge tile end - initial



Crest ridge tile end - final



Venting flue



Ridge tile - crest connector - universal tee model 1



Ridge tile - crest connector - universal tee model 2



Ridge tile - crest connector - cross-piece



Chimney sweep bench 40 cm, set*



Chimney sweep bench 80 cm, set



Ventilation flue with a \varnothing 150 mm connection pipe



Chimney sweep step, set*



Snow catcher*



Anti-snow fence 200 cm, set (copper, brown, chestnut)*



Skylight tile

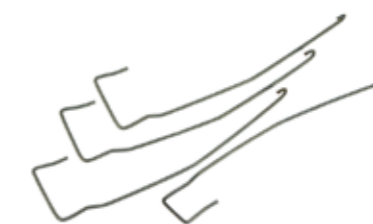

Roofing tile clamp 4x6



Crest beam clamp



Eaves comb (1 l.m.)



Chimney sweep tape/chimney tape w. 300 mm (1 l.m.)



Ridge tile tape/crest tape w. 300 mm (1 l.m.)

*Accessories available on request



BERGAMO	LAF/FLA (mm)							
Roof inclination angle	25°	30°	35°	40°	45°	50°	55°	60°
RIDGE TILE								
LAF	35	30	28	28	28	30	36	38
FLA	83	75	69	63	55	46	36	31

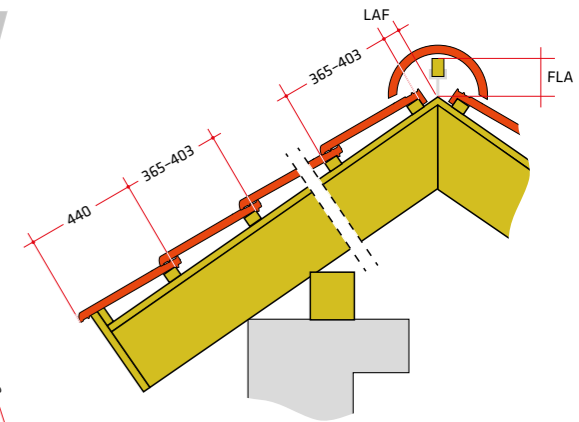

Flat
time

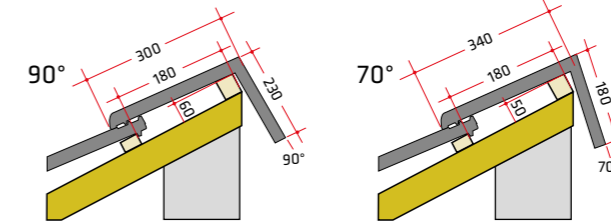

Cross-section of the roof cover.

Proper assembly depends, inter alia, on the shape of the roof and location of the house, which is why it may be different from the solutions presented here. The best option is to consult a qualified roofer. Please read the guidelines for proper roof ventilation. Details can be found in the information sheets at www.en.roben.pl.

Available colours of roof tiles

Technical data*

Weight (1 item)	ca. 3.95 kg
Total length	ca. 43.6 cm
Total width	ca. 28.5 cm
Length of cover	ca. 33.3–36.1 cm
Average width of cover	ca. 23.7 cm
Minimum design value/m²	ca. 12 items
Quantity/m ²	ca. 11.8–12.8 items
Minimum roof inclination angle	up to 25°
Quantity/EURO pallet	240 items
Weight per sqm	ca. 48.5 kg
Weight of full pallet	ca. 975 kg
Frost resistance	yes

* technical parameters may be slightly changed

Properties

- perfectly flat roof area
- tight cover thanks to precise interlocks
- possibility of putting roof tiles in a series or with a shift

BERGAMO / Anthracite slipped



perfectly flat
roof area

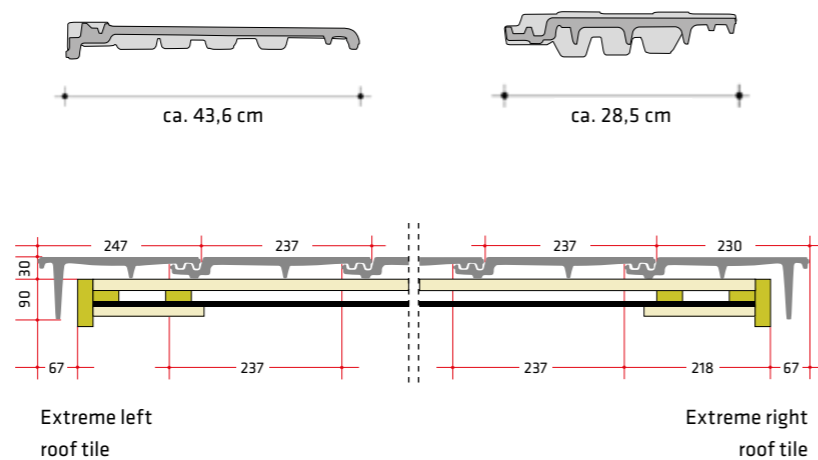

Extreme left
roof tile

Extreme right
roof tile



Left edge tile (cornice)



Right edge tile (cornice)



Ventilating tile



1/2 Tile



DK Tile



Basic ridge tile with a clamp
- 2.9 pcs./l.m.



Edging ridge tile*



Ridge tile - crest connector*



Crest ridge tile end - initial



Crest ridge tile end - final



Edging ridge tile end
- initial



Edging ridge tile end
- final



Ridge tile - crest connector
- universal tee model 2



Large, semi-circular
initial ridge tile



Ridge tile - crest connector
- cross-piece



Venting flue with a ø 100 mm
connection pipe

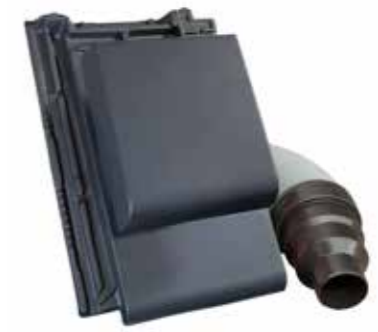

Ventilation flue with a ø 150 mm
connection pipe



Chimney sweep bench 40 cm,
set*



Chimney sweep bench 80 cm,
set



Chimney sweep step, set*



Anti-snow fence 200 cm, set
(copper, brown, chestnut)*



Snow catcher*



Skylight tile

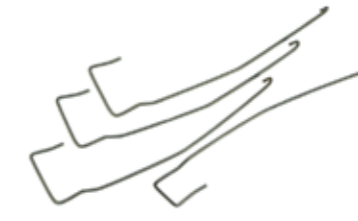

Roofing tile clamp 4x6



Crest beam clamp



Eaves comb (1 l.m.)

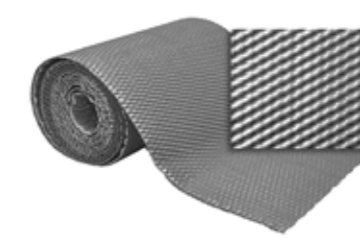

Chimney sweep tape/chimney
tape w. 300 mm (1 l.m.)



Ridge tile tape/crest tape
w. 300 mm (1 l.m.)



PIEMONTE	LAF/FLA (mm)									
Roof inclination angle	22°	25°	30°	35°	40°	45°	50°	55°	60°	
RIDGE TILE										
LAF	70	70	65	60	55	55	55	50	50	
FLA	110	105	100	90	85	75	70	60	50	

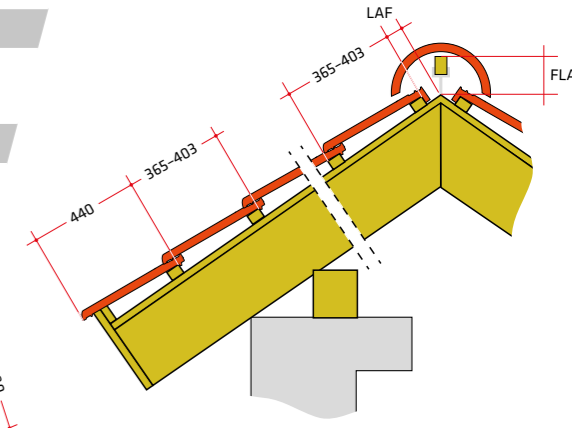

Flat
time

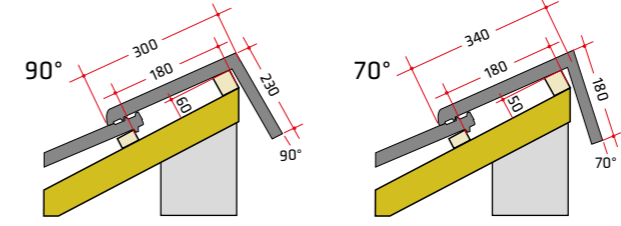

Cross-section of the roof cover.

Proper assembly depends, inter alia, on the shape of the roof and location of the house, which is why it may be different from the solutions presented here. The best option is to consult a qualified roofer. Please read the guidelines for proper roof ventilation. Details can be found in the information sheets at www.en.roben.pl.

Technical data*

Weight (1 item)	ca. 3.97 kg
Total length	ca. 47.2 cm
Total width	ca. 29.0 cm
Length of cover	ca. 36.5–40.3 cm
Average width of cover	ca. 24,5 cm
Minimum design value/m ²	ca. 10,1 items
Quantity/m ²	ca. 10.1–11.2 items
Minimum roof inclination angle	up to 22°
Quantity/EURO pallet	240 items
Weight per sqm	ca. 40.1–44.5 kg
Weight of full pallet	ca. 983 kg
Frost resistance	yes

* technical parameters may be slightly changed

Properties

- high leaktightness
- strength
- attractive design
- lighter roof
- attractive price
- average length of cover ca. 365–403 mm



Average length of cover ca. 365–403 mm

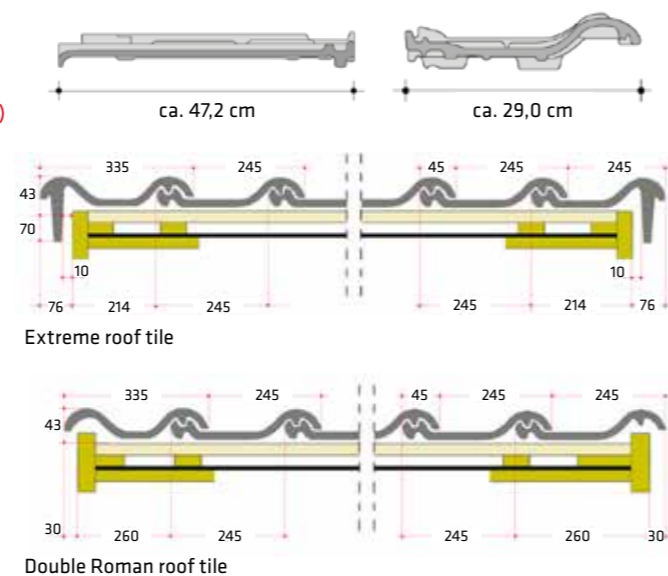

Graphite engobe



Titan grey glazed



Brown slipped



Chestnut slipped



Tobago glazed



Copper slipped



Anthracite slipped

Available colours of roof tiles

PIEMONT / Graphite engobe

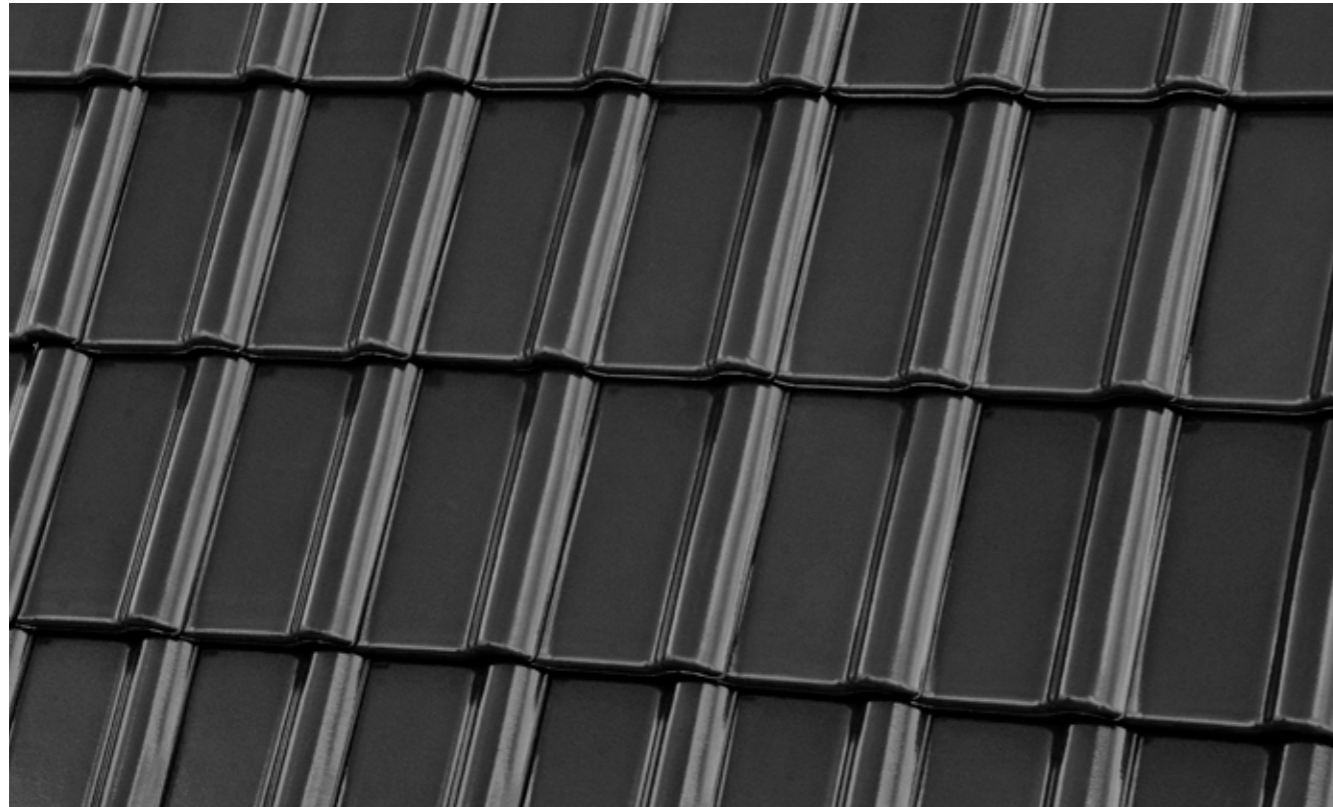

PIEMONT / Chestnut slipped



PIEMONT / Titan grey glazed



PIEMONT / Copper slipped



PIEMONT / Tobago glazed



PIEMONT / Brown slipped



PIEMONT / Anthracite slipped





Left edge tile
(2.5 pcs./l.m.)



Right edge tile
(2.5 pcs./l.m.)



Ventilating tile



1/2 Tile



Double roll tile



Terminal edging tile*



Standard edging tile*



Solar tile (1 set = 2 pcs.)



Ridge tile - crest connector
- cross-piece



Venting flue with
a \varnothing 100 mm connection pipe



Ventilation flue with
a \varnothing 150 mm connection pipe



Chimney sweep bench 40 cm, set*



Chimney sweep bench 80 cm, set



Chimney sweep step, set*



Snow catcher*



Anti-snow fence 200 cm, set
(copper, brown, chestnut)*



Ceramic antenna tile



Basic ridge tile with
a clamp - 2.9 pcs./l.m.



Crest ridge tile end
- initial



Crest ridge tile end
- final



Skylight tile



Roofing tile clamp 4x6



Crest beam clamp



Large, semi-circular
initial ridge tile



Ridge tile - crest connector
- universal tee model 1



Ridge tile - crest connector
- universal tee model 2



Eaves comb (1 l.m.)



Chimney sweep tape/chimney tape
w. 300 mm (1 l.m.)



Ridge tile tape/crest tape
w. 300 mm (1 l.m.)



MONZAplus	LAF/FLA (mm)									
Roof inclination angle	22°	25°	30°	35°	40°	45°	50°	55°	60°	
RIDGE TILE										
LAF	65	65	65	50	50	50	40	35	35	
FLA	110	105	100	90	85	80	80	70	65	

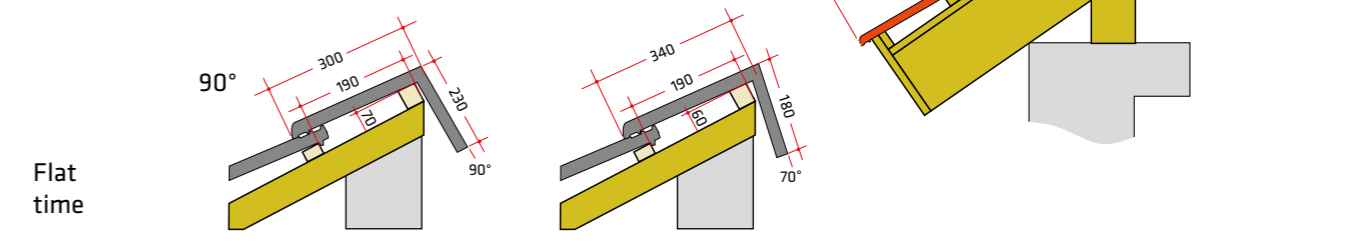

Cross-section of the roof cover.

Proper assembly depends, inter alia, on the shape of the roof and location of the house, which is why it may be different from the solutions presented here. The best option is to consult a qualified roofer. Please read the guidelines for proper roof ventilation. Details can be found in the information sheets at www.en.roben.pl.

Available colours of roof tiles

Technical data*

- Weight (1 item) ca. 4.07 kg
- Total length ca. 46.4 cm
- Total width ca. 30.4 cm
- Length of cover ca. 38.3–40.3 cm
- Average width of cover ca. 26.3 cm
- Minimum design value/m² ca. 9,5 items
- Quantity/m² ca. 9.4–9.9 items
- Minimum roof inclination angle up to 22°
- Quantity/EURO pallet 240 items
- Weight per sqm ca. 38.3–40.3 kg
- Weight of full pallet ca. 1007 kg
- Frost resistance yes

* technical parameters may be slightly changed

Properties

- large size
- smaller consumption per m²
– only 9.4–9.9 items are enough!
- fast assembly
- lighter roof
- attractive price

Additional teeth, located at the side edge of the roof tile, guarantee more durable and stable connection of the roof tile to the patch section. ▶

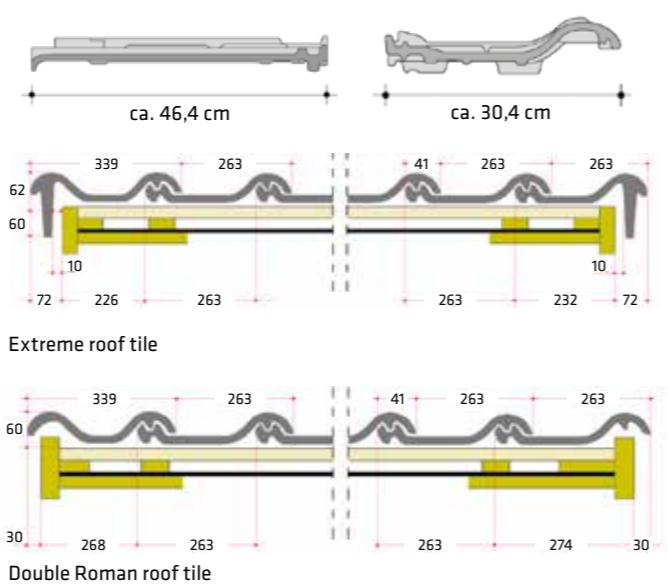

Graphite slipped



Maduro glazed



Anthracite slipped



Tobago glazed



Copper slipped



Chestnut slipped



Trentino slipped

MONZAplus / Graphite slipped



MONZAplus / Tobago glazed



MONZAplus / Anthracite slipped



MONZAplus / Maduro glazed



MONZAplus / Trentino slipped



MONZAplus / Chestnut slipped



MONZAplus / Copper slipped





Left edge tile
(2.5 pcs./l.m.)



Right edge tile
(2.5 pcs./l.m.)



Ventilating tile



1/2 Tile



Double roll tile



Standard edging tile*



Right terminal
edging tile



Left terminal
edging tile



Solar tile (1 set = 2 pcs.)



Antenna tile



Crest ridge tile end
- initial



Crest ridge tile end
- final



Basic ridge tile with
a clamp - 2.9 pcs./l.m.



Ridge tile - crest connector
- universal tee model 1



Ridge tile - crest connector
- universal tee model 2



Large, semi-circular
initial ridge tile



Venting flue with
a \varnothing 100 mm connection pipe



Ventilation flue with
a \varnothing 150 mm connection pipe



Ridge tile - crest connector
- cross-piece



Chimney sweep bench 40 cm,
set*



Chimney sweep bench 80 cm,
set



Chimney sweep step, set*



Anti-snow fence 200 cm, set
(copper, brown, chestnut)*



Snow catcher*



Solar tile (1 set = 2 pcs.)



Antenna tile



Crest ridge tile end
- initial



Crest ridge tile end
- final



Skylight tile



Roofing tile clamp 4x6



Crest beam clamp



Eaves comb (1 l.m.)



Chimney sweep tape/chimney tape
w. 300 mm (1 l.m.)



Ridge tile tape/crest tape
w. 300 mm (1 l.m.)

Gallery



Factory



Production facilities in Środa Śląska

Röben

Röben is a part of a family-owned concern that has been manufacturing ceramic building materials for **more than 160 years**. The Frisian brickyards, established in the mid-19th century, are what today's chain of factories located in Europe and America originated from. In 1995 the factory in Środa Śląska became a part of the company cherishing such a long-established tradition. This is where the largest and the most modern roof tile factory in Europe was established.

There are many factors that contributed to Röben's success. From local deposits of clay we extract a perfect raw material for the production of bricks, clinker tiles, roof tiles and roof accessories. This natural ceramic raw material, combined with the most modern technological solutions and long experience, provides for the highest quality of the building materials manufactured in our factories. They enable further generations of investors to make the dreams of a beautiful and safe home come true. The best technical parameters, strength, an attractive design and a good price constitute a logical whole.

Röben building ceramics. Reach high!

Ceramic roof tiles and accessories Röben feature a 30-year long quality warranty.

30 years
of WARRANTY



Röben
Gold Building Brand of the Year
2020, 2015, 2014, 2010, 2009, 2008, 2006, 2005, 2004
in the category of Roof Covers



Röben
GOLD MEDAL
MTP POZNAŃ EXPO 2020
Awarded product
Ceramic tile
PIEMONT



Röben
CUSTOMER LAUREL - TOP BRAND 2018
in the category:
'Quality and innovativeness in the building industry'



Röben
CONSUMER QUALITY LEADER 2017



PN-EN 1304: January 2007 ceramic roof tiles. Definition and specification of products Annexe B
In case of unicoloured roof tiles the shades of the colour may differ, which stems from specific methods of the production of ceramic products.

The product colours presented in the catalogue are for demonstrative purposes only and their shades may differ from the real colour of the products. Röben shall bear no liability for any differences between the real colour of the product and the colour presented in the catalogue.

Watch roofing photo gallery:



Röben

Factory:

Röben Polska Sp. z o.o. i Wspólnicy Sp. k.
55-300 Środa Śląska, Ceramiczna Street 2
phone no. 71 39 78 100, fax no. 71 39 78 111
e-mail: biuro@roben.pl

www.en.roben.pl